



电表计量输送案例



工业自动化组装输送案例

Contents (目录)	2	Examples of application (应用场合)	14
Chains (链条)	4		
Conveyor beam (输送梁)	6		
End drive units (驱动单元)	8		
Idler end units (从动单元)	9		
Horizontal plain bends (水平弯头)	11		
Vertical bends (垂直弯头)			

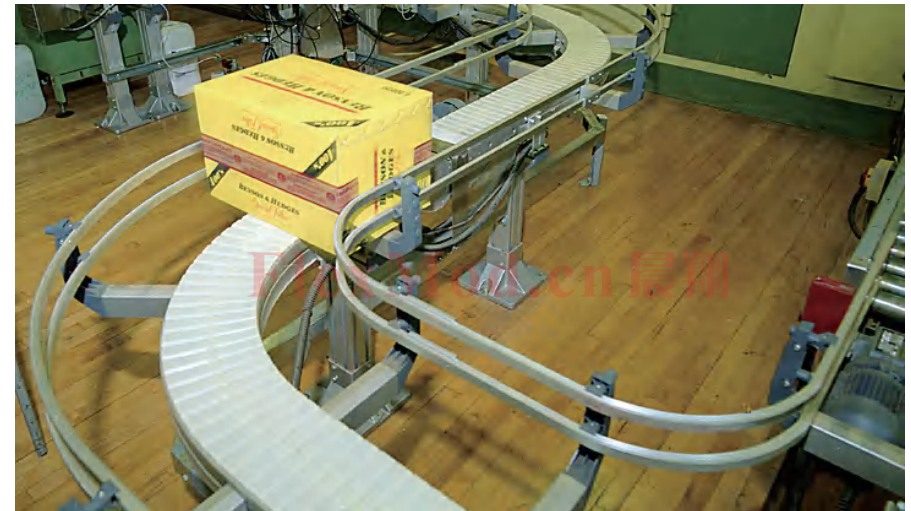

Chain width 175 mm (链宽175mm)



Technical characteristics (技术指标)

Chain tension limit (链条张力极限)1250 N
Beam width (型材宽度)182 mm
Chain width (链条宽度)175 mm
Chain pitch (链条节距)33.5 mm
Item width (输送物品宽度)70-200 mm
Maximum item weight (输送物品重量)	
Horizontal transport (水平传送)15 kg
Maximum weight on conveyor (线体最大承载)200 kg
Maximum conveyor length (线体最大长度)30 m

CXB-175

Examples of application

Large cardboard boxes, products in soft plastic bags. Examples: detergent powder, wrapped tissue paper rolls, food products, personal care products.

应用场合

卡通箱、塑胶袋、包装纸、食品包装、个人用品、化工桶、塑胶瓶

FlexMod.cn 晨翔



Plastic chain materials(链板材质)	Performance(特性)	Colour(颜色)
POM	Standard material/标准材料	white/白色
POML	Ultra low wear/超润滑	white/白色
POMA	Abrasion resistance/超耐磨	white/白色
POMC	Chemical resistance/抗腐蚀	yellow/黄色
POME	Conductive material/抗静电	black/黑色
POMK	High temperature resistance/耐高温	yellow/黄色
POMF	Food application/用于食品	white/白色
POMN	Low noise/低噪音	white/白色

Plain chain (平板链)

CXBTP 3A175 Plain chain (平板链)
Length 5 mt (长度5m)

CXBTL 175 Plain link (平板链节)

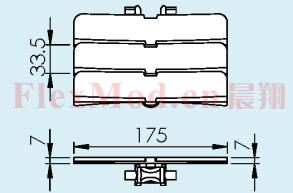

CXBTP 3A175 A Plain chain (平板链)
Length 5 mt (长度5m)

CXBTL 175 A Plain link (平板链节)

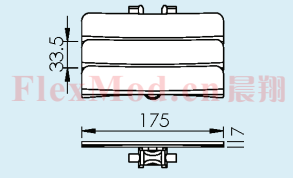
*Friction top chain (防滑顶链)*

CXBTP 3A175 F Plain chain (平板链)
Length 5 mt (长度5m)

CXBTL 175 F Plain link (平板链节)

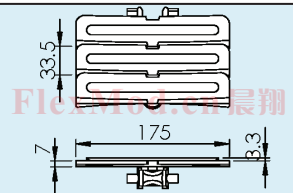

CXBTP 3A175 AF Plain chain (平板链)
Length 5 mt (长度5m)

CXBTL 175 AF Plain link (平板链节)

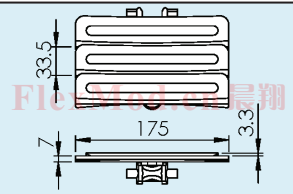

CXBTL 175X46R Roller top chain
(钢顶链)

See Note Plain link (平板链节)

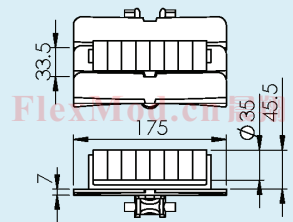

Note. This type of chain requires minimum .One plain link between every cleated link.

Tools and accessories (工具和附件)

CXBTT 13X16 Plastic pivot (塑料珠)

CXMTT 13X16 Plastic pivot (塑料珠)

CXMTD 6X50 Steel pin(钢销)

CXBMJ 6P Pin insertion tool
(销子安装工具)

CXBMJ 6 Pin insertion tool
(销子安装工具)



Conveyor beam (输送梁)

FlexMod®

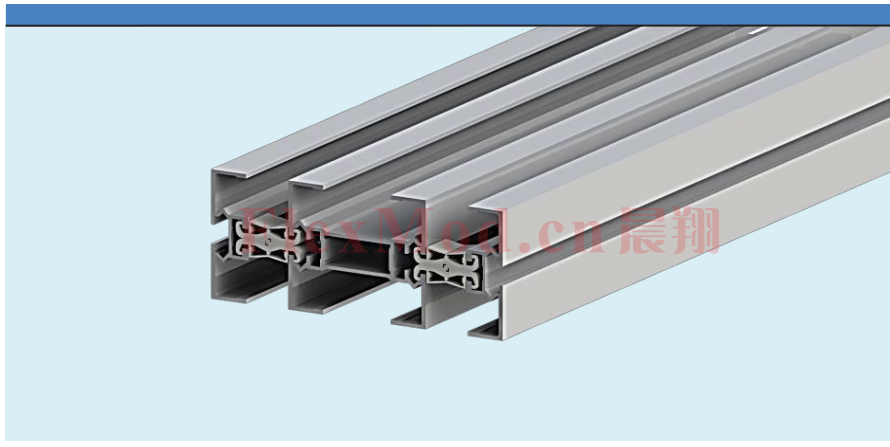

Conveyor beam (输送梁)

FlexMod®

Beam (输送梁)

CXBCB 3A175 Length 3 mt (长度3m)

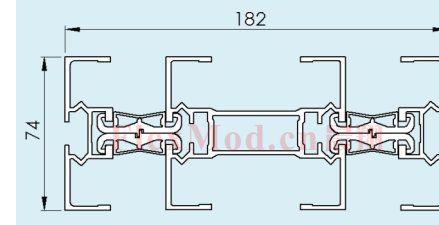

CXBCB 3A85 Length 3 mt (长度3m)

CXBCB 3A H Length 3 mt (长度3m)

CXBCE 40 Snap-fit clip kit for outer beam

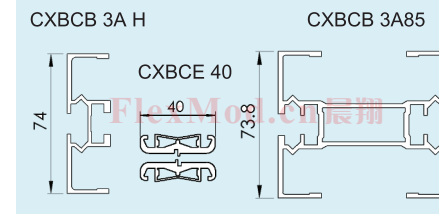

Slide rail (耐磨条) Length 25 m (长度25m)

CXBCE 3 HDPE Gray-black
 CXBCR 25 HDPE Black/White(聚乙烯)
 CXBCR 25P PVDF White(聚偏氟乙烯)

CXLAH 4X8A Aluminium rivet (铝铆钉)
 CXLAG 5 Plastic screw (塑料铆钉)

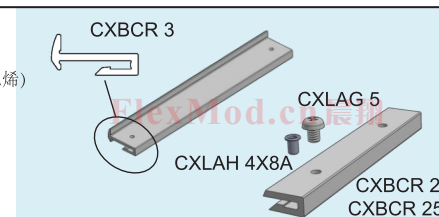

Connecting strip with set screws
 (梁体连接条)

CXSCJ 6X160 H=20 mm
 Length 160 mm

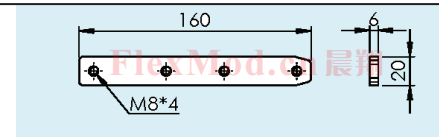

T-slot cover(防尘胶条)

CXCAC 2 Aluminium Length 2 mt

CXCAC 3P Polyvinyl chloride
 Length 3 mt (长度3m)

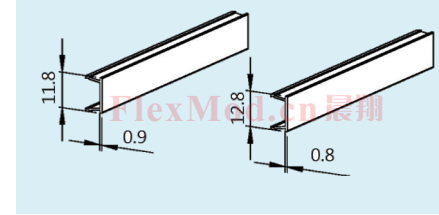

CX3920500 Drill fixture for slide rail (耐磨条安装工具)

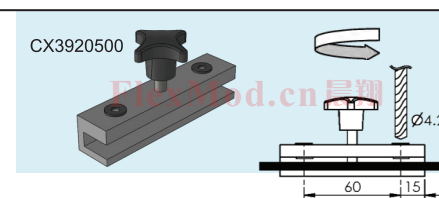

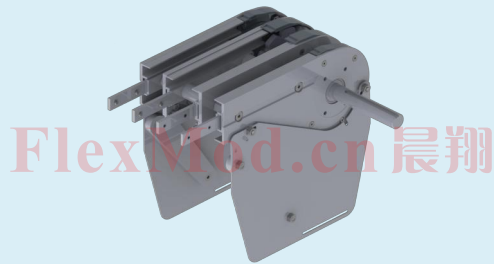

CXBEB 0A175LU Basic drive unit
(基本驱动单元)
Transmission on
left-hand side
(传动装置在左侧)

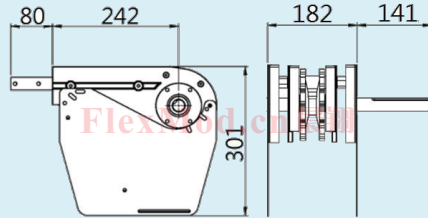

CXBEB 0A175RU Basic drive unit
(基本驱动单元)
Transmission on
right-hand side
(传动装置在右侧)

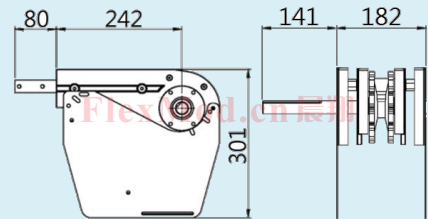

CXBEB 0A175LU Drive unit (驱动单元)
Transmission on
left-hand side
(传动装置在左侧)
SEW SA37
SEW WA 30
SEW WA 20

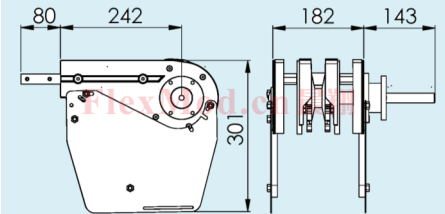

CXBEB 0A175RU Drive unit (驱动单元)
Transmission on
right-hand side
(传动装置在右侧)
SEW SA37
SEW WA 30
SEW WA 20

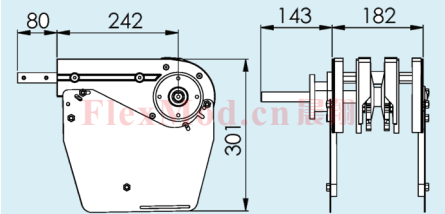

Idler end units (从动单元)

FlexMod®



CXBEJ 175

Idler end unit (从动单元)

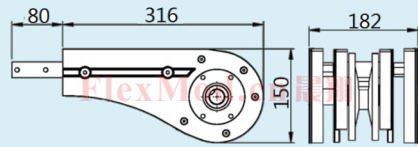

CXB-175-8

Horizontal plain bends (水平弯头)

FlexMod®

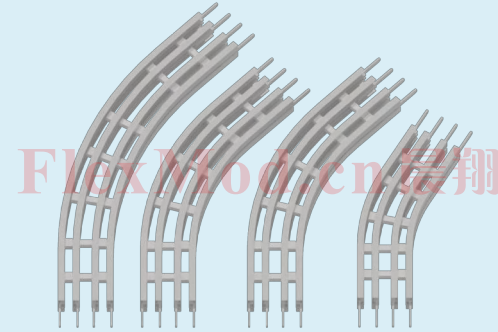

CXB-175

www.flexmod.cn

CXB-175-9

Horizontal plain bends (水平弯头)

FlexMod®

Horizontal plain bend, 30° (水平弯头30°)

Radius to centre of beam:
(输送梁中心半径)

CXBBP 30A175R500	R=500 mm
CXBBP 30A175R700	R=700 mm
CXBBP 30A175R1000	R=1000mm

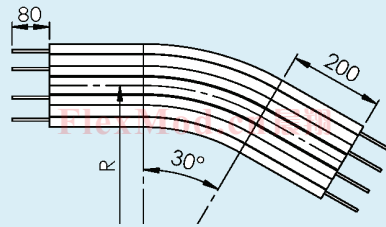

Horizontal plain bend, 45° (水平弯头45°)

Radius to centre of beam:
(输送梁中心半径)

CXBBP 45A175R500	R=500 mm
CXBBP 45A175R700	R=700 mm
CXBBP 45A175R1000	R=1000mm

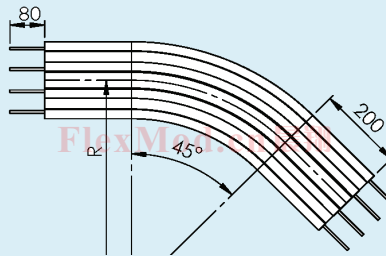

Horizontal plain bend, 60° (水平弯头60°)

Radius to centre of beam:
(输送梁中心半径)

CXBBP 60A175R500	R=500 mm
CXBBP 60A175R700	R=700 mm
CXBBP 60A175R1000	R=1000mm

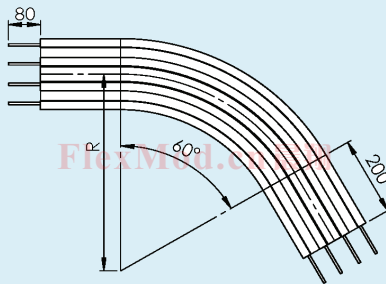

Horizontal plain bend, 90° (水平弯头90°)

Radius to centre of beam:
(输送梁中心半径)

CXBBP 90A175R500	R=500 mm
CXBBP 90A175R700	R=700 mm
CXBBP 90A175R1000	R=1000mm

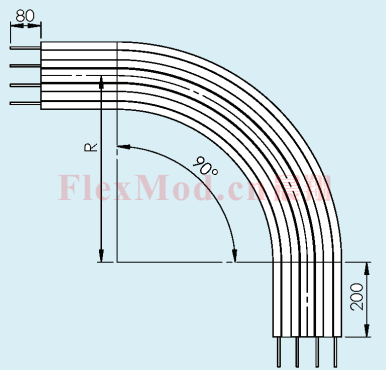

* Note: Special angles on request.

CXB-175-10

Vertical bends (垂直弯头)

FlexMod®



CXB-175

www.flexmod.cn

CXB-175-11

Vertical bends (垂直弯头)

FlexMod®

Vertical bend, 5° (垂直弯头5°)

Radius to centre of beam:
(输送梁中心半径)

CXBBV 5A175 R750 R=750 mm

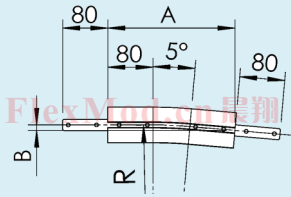

	R	A	B
CXBBV 5A175 R750	750	225	10

Vertical bend, 7° (垂直弯头7°)

Radius to centre of beam:
(输送梁中心半径)

CXBBV 7A175 R750 R=750 mm

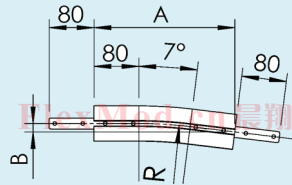

	R	A	B
CXBBV 7A175 R750	750	251	15

Vertical bend, 15° (垂直弯头15°)

Radius to centre of beam:
(输送梁中心半径)

CXBBV 15A170 R750 R=750 mm

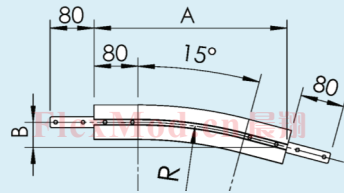

	R	A	B
CXBBV 15A175 R750	750	351	46

Vertical bend, 30° (垂直弯头30°)

Radius to centre of beam:
(输送梁中心半径)

CXBBV 30A175 R750 R=750 mm

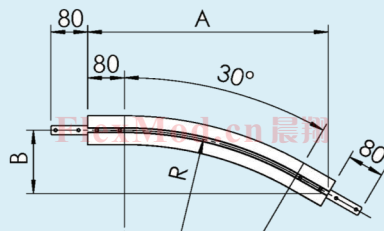

	R	A	B
CXBBV 30A175 R750	750	524	141

* Note: Special angles on request.

CXB-175-12

Vertical bends (垂直弯头)

FlexMod®

Vertical bend, 45° (垂直弯头45°)

Radius to centre of beam:
(输送梁中心半径)

CXBBV 45A175 R750 R=750 mm

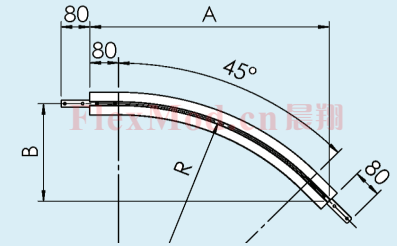

	R	A	B
CXBBV 45A175 R750	750	667	277

Vertical bend, 60° (垂直弯头60°)

Radius to centre of beam:
(输送梁中心半径)

CXBBV 60A175 R750 R=750 mm

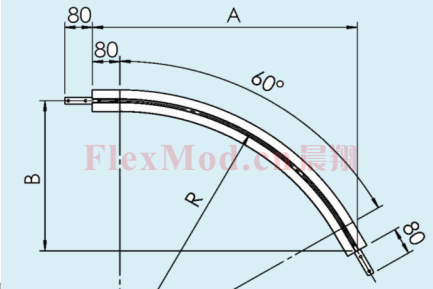

	R	A	B
CXBBV 60A175 R750	750	770	444

Vertical bend, 90° (垂直弯头90°)

Radius to centre of beam:
(输送梁中心半径)

CXBBV 90A175 R750 R=750 mm

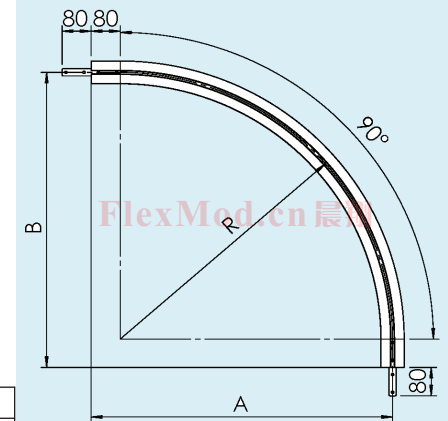

	R	A	B
CXBBV 90A175 R750	750	830	830

CXB-175

www.flexmod.cn

CXB-175-13